

SAFARI - Profilverst

Dansk produktion - dansk design
Produceret i aluminium, som er fuld genanvendelig

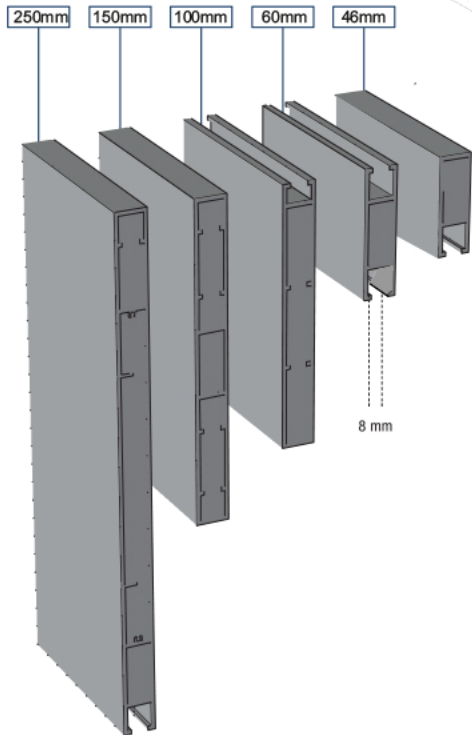

Bokse i faste h3jlder - l3engde efter opgave



Paneler kan laves efter opgave

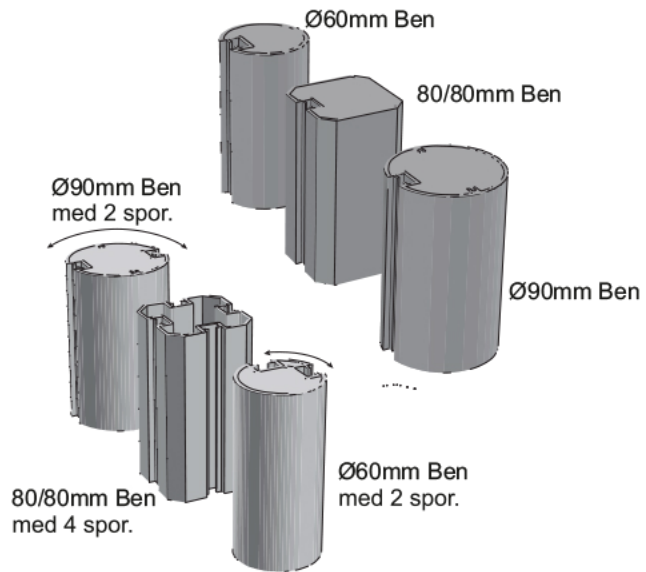

Topl3g for Ø60mm Ben

Topl3g for 80/80mm Ben

Topl3g for Ø90mm Ben

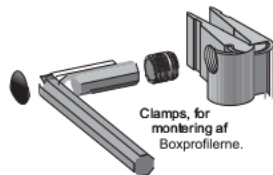

Clamps, for montering af Boxprofilerne.

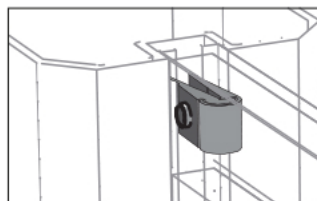
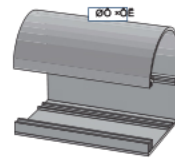

Set fra siden

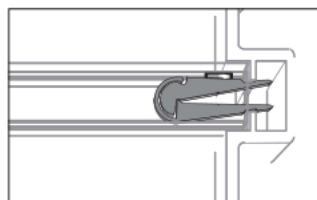

Set fra oven

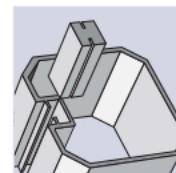

D3ekliste, for montering i spor p3a ben, som skjuler

